

## DIXIT RECESSED

### A5601121-30K

#### GENERAL

Series: Dixit

Brand: Ivela

Division: Architectural

Mounting Type: Recessed

Mounting Location: Ceiling

Subcategory: Downlight

#### PHYSICAL

Shape: Round

Diameter (mm): 95

Diameter (in): 3 <sup>3</sup>/<sub>4</sub>

Depth (mm): 82

Depth (in): 3 <sup>1</sup>/<sub>4</sub>

Min. Recessing Depth (mm): 122

Min. Recessing Depth (in): 4 <sup>13</sup>/<sub>16</sub>

Weight (kg): 0.4

Weight (lbs): 0.88

Fixture Finish: WHI

Cut-out Measurements: 86mm / 3 3/8

#### ELECTRICAL

Input Wattage Range: 10 - 19 W

Lamp Type: LED

Input Wattage (W): 9.5

Dimming: Tri-Mode (Non-Dimming and Phase Dimming (120Vac only) and 0-10V Dimming)

Driver Included: No

Driver Location: Recessed Housing

Driver Type: Constant Current - Universal

Driver Class: Class 2

Input Voltage (V): 120 - 277

Constant Current (mA): 350

#### LED

Delivered Lumen Range: 1000 - 1999 lm

Number of LEDs: 1

Color Temperature (°K): 3000

Max. Delivered Lumen (lm): 1000

CRI: &gt;80 CRI

Efficiency (%): 91

Lamp Life (hrs): 50000

#### OPTICAL

Optic°: 24

Adjustability: Tilt 20°

#### RATINGS AND CERTIFICATIONS

Certified By: CSA Certified to UL and CSA Standards

IP rating: IP20

IK Rating: IK08

Glare Rating: ≤ 19



## DIXIT RA8 RECESSED

### L5600421

#### GENERAL

Series: Dixit \_\_\_\_\_

Subseries: Dixit RA8 \_\_\_\_\_

Brand: Ivela \_\_\_\_\_

Division: Architectural \_\_\_\_\_

Mounting Type: Recessed \_\_\_\_\_

Mounting Location: Ceiling \_\_\_\_\_

Subcategory: Downlight \_\_\_\_\_

#### PHYSICAL

Shape: Round \_\_\_\_\_

Diameter (mm): 96 \_\_\_\_\_

Diameter (in): 3 <sup>3</sup>/<sub>4</sub> \_\_\_\_\_

Height (mm): 85 \_\_\_\_\_

Height (in): 3 <sup>3</sup>/<sub>8</sub> \_\_\_\_\_

Min. Recessing Depth (mm): 125 \_\_\_\_\_

Min. Recessing Depth (in): 4 <sup>15</sup>/<sub>16</sub> \_\_\_\_\_

Light Distribution: Direct \_\_\_\_\_

Weight (kg): 0.5 \_\_\_\_\_

Weight (lbs): 1.1 \_\_\_\_\_

Diffuser: Clear Polycarbonate \_\_\_\_\_

Fixture Finish: MWH \_\_\_\_\_

Fixture Material: Aluminum Die Cast \_\_\_\_\_

Cut-out Measurements: 92mm (3 5/8") \_\_\_\_\_

#### ELECTRICAL

Input Wattage Range: 1 - 9 W \_\_\_\_\_

Lamp Type: LED \_\_\_\_\_

Total Output Wattage (W): 6.5 \_\_\_\_\_

Driver Included: No \_\_\_\_\_

Driver Location: Recessed Housing \_\_\_\_\_

Housing: See components \_\_\_\_\_

Constant Current (MA): 250 \_\_\_\_\_

#### LED

Color Temperature (°K): 3000 \_\_\_\_\_

CRI: &gt;80 CRI \_\_\_\_\_

Lamp Life (hrs): 50000 \_\_\_\_\_

#### OPTICAL

Reflector°: 25 \_\_\_\_\_

#### RATINGS AND CERTIFICATIONS

IP rating: IP44 \_\_\_\_\_

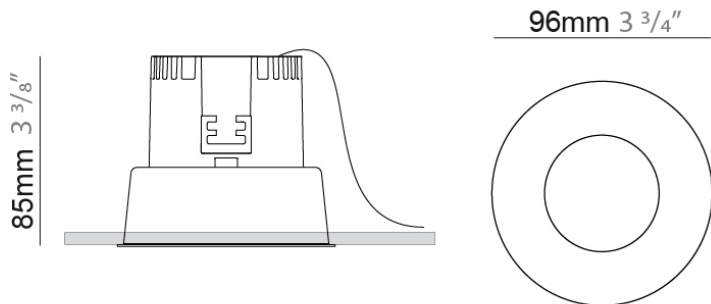

## DIXIT RA8 RECESSED

### L5600521

PROJECT	
TYPE	
NOTES	
QUANTITY	
DATE	

#### GENERAL

Series: Dixit  
 Subseries: Dixit RA8  
 Brand: Ivela  
 Division: Architectural  
 Mounting Type: Recessed  
 Mounting Location: Ceiling  
 Subcategory: Downlight

#### PHYSICAL

Shape: Round  
 Diameter (mm): 96  
 Diameter (in): 3 3/4  
 Height (mm): 110  
 Height (in): 4 5/16  
 Min. Recessing Depth (mm): 150  
 Min. Recessing Depth (in): 5 7/8  
 Light Distribution: Downlight  
 Weight (kg): 0.5  
 Weight (lbs): 1.10  
 Installation Requirement: Housing Required  
 Fixture Material: Aluminum

#### ELECTRICAL

Input Wattage Range: 10 - 19 W  
 Lamp Type: LED  
 Total Output Wattage (W): 9.5  
 Dimming: Tri-Mode (Non-Dimming and Phase Dimming (120Vac only) and 0-10V Dimming)  
 Driver Included: No  
 Driver Location: Recessed Housing  
 Driver Type: Constant Current - Universal  
 Driver Class: Class 2  
 Input Voltage (V): 120 - 277  
 Constant Current (mA): 350

#### LED

Color Temperature (°K): 3000  
 Max. Delivered Lumen (lm): 983  
 Nominal Lumen (lm): 1000  
 CRI: >80 CRI  
 Lamp Life (hrs): 50000

#### OPTICAL

Reflector°: 24

#### RATINGS AND CERTIFICATIONS

Certified By: Certified for North American Standards  
 IP rating: IP44



## DIXIT RA8 RECESSED

### L5600821

PROJECT	
TYPE	
NOTES	
QUANTITY	
DATE	

#### GENERAL

Series: Dixit  
 Subseries: Dixit RA8  
 Brand: Ivela  
 Division: Architectural  
 Mounting Type: Recessed  
 Mounting Location: Ceiling  
 Subcategory: Downlight

#### PHYSICAL

Shape: Round  
 Diameter (mm): 80  
 Diameter (in): 3 1/8  
 Height (mm): 50  
 Height (in): 1 15/16  
 Min. Recessing Depth (mm): 90  
 Min. Recessing Depth (in): 3 9/16  
 Light Distribution: Downlight  
 Weight (kg): 0.5  
 Weight (lbs): 1.1  
 Installation Requirement: Housing Required  
 Fixture Material: Aluminum

#### ELECTRICAL

Lamp Type: LED  
 Total Output Wattage (W): 6.5  
 Input Voltage (V): 120  
 Constant Current (MA): 350

#### LED

Color Temperature (°K): 3000  
 Max. Delivered Lumen (lm): 501  
 Nominal Lumen (lm): 550  
 CRI: >80 CRI  
 Lamp Life (hrs): 50000

#### OPTICAL

Optic°: 24

#### RATINGS AND CERTIFICATIONS

Certified By: Certified for North American Standards

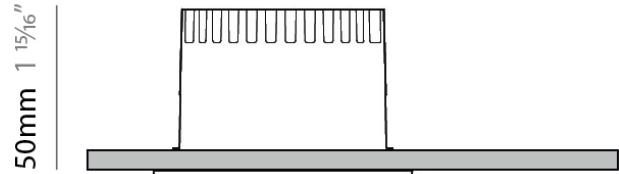

Ø80mm 3 1/8"



Ø70mm  
2 3/4"

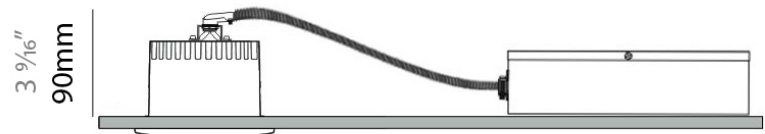

A

## DIXIT RA8 RECESSED

### L5600921

PROJECT	
TYPE	
NOTES	
QUANTITY	
DATE	

#### GENERAL

Series: Dixit  
 Subseries: Dixit RA8  
 Brand: Ivela  
 Division: Architectural  
 Mounting Type: Recessed  
 Mounting Location: Ceiling  
 Subcategory: Downlight

#### PHYSICAL

Shape: Round  
 Diameter (mm): 80  
 Diameter (in): 3 1/8  
 Height (mm): 81  
 Height (in): 3 3/16  
 Min. Recessing Depth (mm): 121  
 Min. Recessing Depth (in): 4 3/4  
 Light Distribution: Downlight  
 Installation Requirement: Housing Required  
 Fixture Material: Aluminum

#### ELECTRICAL

Input Wattage Range: 1 - 9 W  
 Lamp Type: LED  
 Total Output Wattage (W): 9.2  
 Dimming: Tri-Mode (Non-Dimming and Phase Dimming (120Vac only) and 0-10V Dimming)  
 Driver Included: No  
 Driver Location: Recessed Housing  
 Driver Type: Constant Current - Universal  
 Driver Class: Class 2  
 Input Voltage (V): 120 - 277  
 Constant Current (mA): 250

#### LED

Color Temperature (°K): 3000  
 Max. Delivered Lumen (lm): 983  
 Nominal Lumen (lm): 1000  
 CRI: >80 CRI  
 Lamp Life (hrs): 50000

#### OPTICAL

Optic°: 24

#### RATINGS AND CERTIFICATIONS

Certified By: CSA Certified to UL and CSA Standards  
 IP rating: IP44



Ø80mm 3 1/8"

Ø50mm 2"



Ø70mm  
2 3/4"











4 3/4"  
121mm













## LEGEND

	floor-mounted		pivotal		special LED (upon request) RGB, RGBW, tunable, gold+, meat+, art+, fashion+
	wall and ceiling: recessed and surface mounted		rotating		warm dim / natural dimming LED
	ceiling-mounted and wall-mounted		illuminate tilted		rechargeable battery powered
	wall-mounted		color of suspension cable		fixture with natural vivid LED (upon request)
	omni-directional light distribution		length of suspension cable		color rendering index
	direct light distribution		reflector degree selection		color temperature
	direct/indirect light distribution		super spot		lumen (luminous flux)
	indirect light distribution		lens		efficacy (lumens per watt)
	asymmetric light distribution		lens pack		Unified Glare Rating (UGR) range from 5-40
	aura light distribution		shine ring		marine grade (AISI 316 stainless steel)
	round wall or ceiling cut-out		integrated shine ring with diffuser		walk on
	square wall or ceiling cut-out		free individual colors 01-29		drive on
	the supplied jig specifies the cutout dimensions		individual colors: 00 (free of charge), 01-25 (extra charge)		Dark Sky Compliance
	minimum distance (meters) lamp - object		luminaire part to be colored (F1)		Americans with Disabilities Act (less than 4" off the wall located between 27"-84" from floor)
	recessed depth		luminaire part to be colored (F2)		lamp protected against explosion
	ceiling thickness in mm		luminaire part to be colored (F3)		blown glass using traditional methods by master glass blower
	ceiling thickness selection		luminaire part to be colored (F4)		acoustic material
	dimmable DP (phase), DV (0-10V), DD (dali), DS (step-dim)		luminaire part to be colored (F5)		protection class I, protection insulation
	included or excluded LED driver/transformer/control gear		color of 3-circuit adaptor		protection class II, protection insulation
	separately switchable		indirect diffuser		ETL Certified to UL and CSA Standards
	sensor		direct diffuser		UL Certified to UL and CSA Standards
	remote control		ball-proof (upon request)		CSA Certified to UL and CSA Standards
	available upon request		accessory		Certified for North American Standards

## IP RATING

	protected against ingress of solid bodies greater than 12.5mm (finger)
	protected against ingress of solid bodies greater than 2.5mm protected against sprays of water up to 60 degrees from the vertical (rain)
	protected against ingress of solid bodies greater than 1mm (wire) no protection against the ingress of moisture
	protected against ingress of solid bodies greater than 1mm (wire) protected against sprays of water up to 60 degrees from the vertical (rain)
	protected against ingress of solid bodies greater than 1mm (wire) protected against water splashed from all directions
	protected against limited ingress of dust (wet rooms/covered outdoor areas) protected against water splashed from all directions
	protected against ingress of dust protected against jets of water
	protected against ingress of dust protected against powerful jets of water or heavy seas
	protected against ingress of dust protected against immersion of water between 15cm - 1m for 30 minutes
	protected against ingress of dust protected against immersion of water under pressure for long periods

## IK RATING

	protected against 0.14 joules impact (equivalent to 0.25kg mass dropped from 56mm above the surface)
	protected against 0.2 joules impact (equivalent to 0.25kg mass dropped from 80mm above the surface)
	protected against 0.35 joules impact (equivalent to 0.25kg mass dropped from 140mm above the surface)
	protected against 0.5 joules impact (equivalent to 0.25kg mass dropped from 200mm above the surface)
	protected against 0.7 joules impact (equivalent to 0.25kg mass dropped from 280mm above the surface)
	protected against 1 joules impact (equivalent to 0.25kg mass dropped from 400mm above the surface)
	protected against 2 joules impact (equivalent to 0.5kg mass dropped from 400mm above the surface)
	protected against 5 joules impact (equivalent to 1.7kg mass dropped from 300mm above the surface)
	protected against 10 joules impact (equivalent to 5.0kg mass dropped from 200mm above the surface)
	protected against 20 joules impact (equivalent to 5.0kg mass dropped from 400mm above the surface)